

P1 CONFIG.

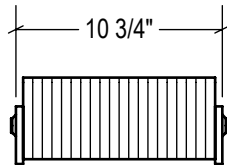

P2 CONFIG.

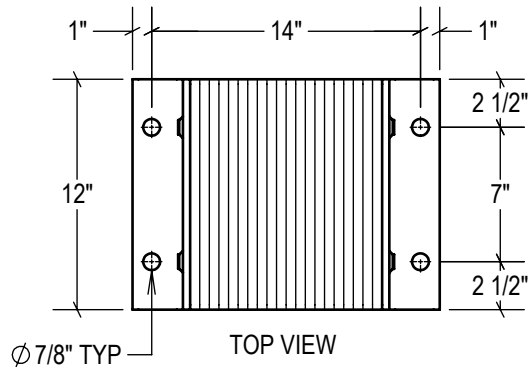

TOP VIEW

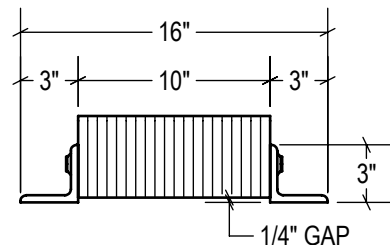

FRONT VIEW

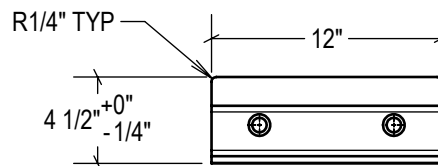

SIDE VIEW

STANDARD  
model #: LB412-14  
part #: 24-1003  
Bolted (2) Sides

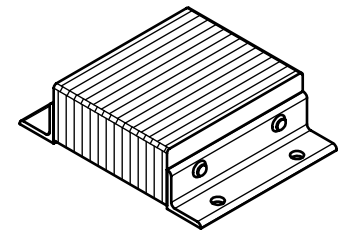

P1 CONFIG.  
model #: LB412-14/P1  
part #: 24-1004  
Welded (1) Side

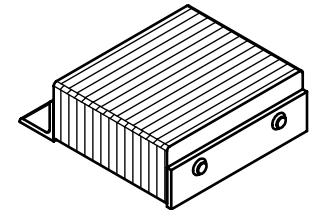

P2 CONFIG.  
model #: LB412-14/P2  
part #: 24-1005  
Welded (2) Sides

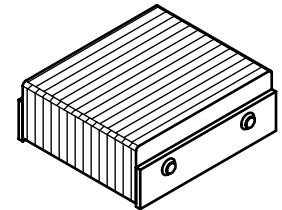

ESTIMATED GROSS SHIPPING WEIGHT = 37 LBS

**SPECIFICATIONS:**

FURNISH AND INSTALL LAMINATED RUBBER DOCK BUMPERS AS MANUFACTURED BY IDEAL WAREHOUSE INNOVATIONS, INC. LAMINATED PADS SHALL BE MADE FROM REINFORCED TRUCK TIRES CUT TO 4.125" x12" PUNCHED AND ASSEMBLED THROUGH 3/4" RODS BETWEEN 3" x 3" x 3/8" STRUCTURAL STEEL UNDER 1,500LBS OF PRESSURE. FINISH OF EXPOSED METAL SHALL BE PAINTED WITH WATER-BASED AND LEAD-FREE PAINT OR HOT-DIPPED GALVANIZED (OPTIONAL).

ALL DIMENSIONS ARE ± 1/8" UNLESS SPECIFIED OTHERWISE

DRAWN BY:

**T.CHUNG**

DATE:

**2018-12-12**

CHECKED BY:

DATE:

THE INFORMATION CONTAINED IN THIS DRAWING IS THE SOLE PROPERTY OF IDEAL WAREHOUSE INNOVATIONS INC. ANY REPRODUCTION IN PART OR AS A WHOLE IS PROHIBITED.



3rd Angle

SIZE:

**A**



**IDEAL WAREHOUSE INNOVATIONS INC**

DESCRIPTION:  
**LAMINATED RUBBER BUMPER LB412-14**

SCALE: <b>1:10</b>	SHEETS: <b>1 of 1</b>	DRAWING NUMBER: <b>MKT_LB412-14</b>	REV: <b>1</b>
-----------------------	--------------------------	--	------------------