

P1 CONFIG.

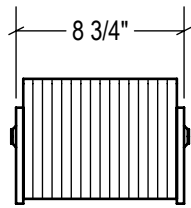

P2 CONFIG.

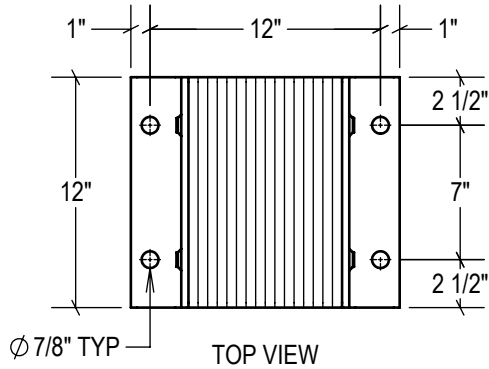

TOP VIEW

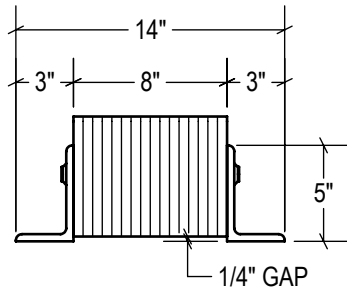

FRONT VIEW

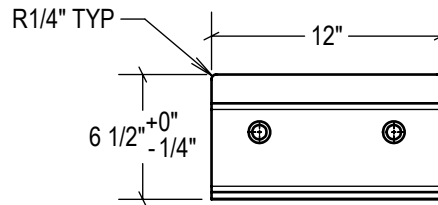

SIDE VIEW

STANDARD
model #: LB612-12
part #: 24-2000
Bolted (2) Sides

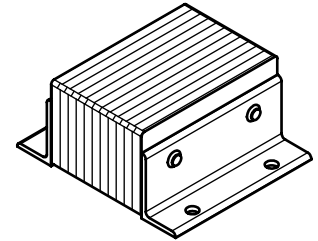

P1 CONFIG.
model #: LB612-12/P1
part #: 24-2001
Welded (1) Side

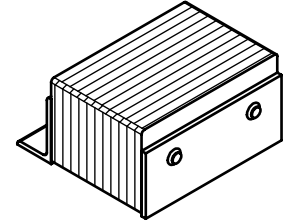

P2 CONFIG.
model #: LB612-12/P2
part #: 24-2002
Welded (2) Sides

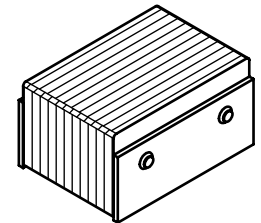

ESTIMATED GROSS SHIPPING WEIGHT = 46 LBS

SPECIFICATIONS:

FURNISH AND INSTALL LAMINATED RUBBER DOCK BUMPERS AS MANUFACTURED BY IDEAL WAREHOUSE INNOVATIONS, INC. LAMINATED PADS SHALL BE MADE FROM REINFORCED TRUCK TIRES CUT TO 6.125" x 12" PUNCHED AND ASSEMBLED THROUGH 3/4" RODS BETWEEN 3" x 5" x 3/8" STRUCTURAL STEEL UNDER 1,500LBS OF PRESSURE. FINISH OF EXPOSED METAL SHALL BE PAINTED WITH WATER-BASED AND LEAD-FREE PAINT OR HOT-DIPPED GALVANIZED (OPTIONAL).

ALL DIMENSIONS ARE ± 1/8" UNLESS SPECIFIED OTHERWISE

DRAWN BY:

T.CHUNG

DATE:

2018-12-12

CHECKED BY:

DATE:

THE INFORMATION CONTAINED IN THIS DRAWING IS THE SOLE PROPERTY OF IDEAL WAREHOUSE INNOVATIONS INC. ANY REPRODUCTION IN PART OR AS A WHOLE IS PROHIBITED.



3rd Angle

SIZE:

A



IDEAL WAREHOUSE INNOVATIONS INC

DESCRIPTION:
LAMINATED RUBBER BUMPER LB612-12

SCALE: 1:10	SHEETS: 1 of 1	DRAWING NUMBER: MKT_LB612-12	REV: 1
-----------------------	--------------------------	--	------------------