

P1 CONFIG.

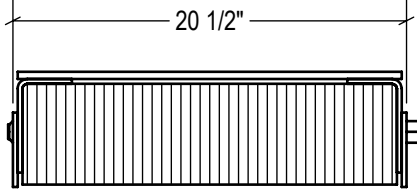

P2 CONFIG.

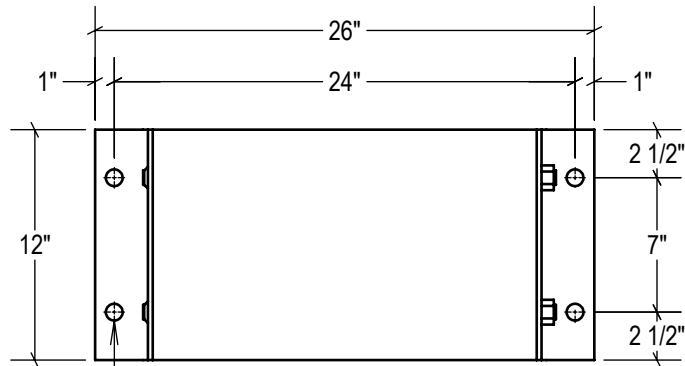

TOP VIEW

Ø 7/8" TYP

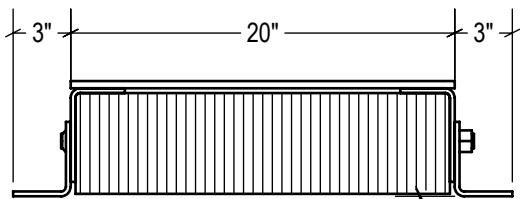

FRONT VIEW

1/8" GAP

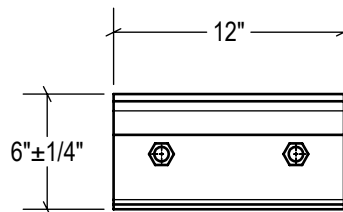

SIDE VIEW

STANDARD
model #: LB612-24SF
part #: 22-2006
Bolted (2) Sides

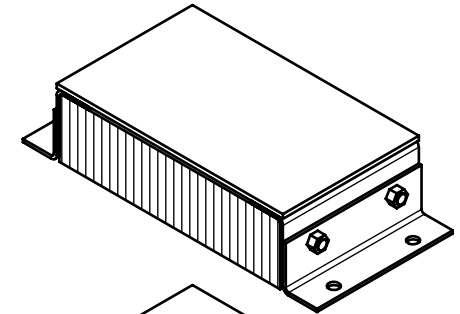

P1 CONFIG.
model #: LB612-24SF/P1
part #: 22-2007
Welded (1) Side

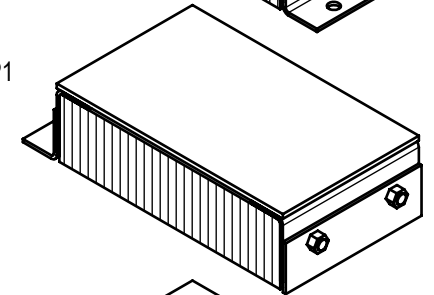

P2 CONFIG.
model #: LB612-24SF/P2
part #: 22-2008
Welded (2) Sides

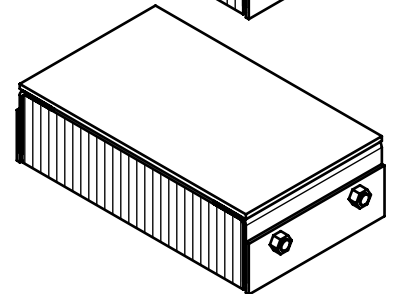

ESTIMATED GROSS SHIPPING WEIGHT = 104 LBS

SPECIFICATIONS:

FURNISH AND INSTALL STEEL-FACED LAMINATED RUBBER DOCK BUMPERS AS MANUFACTURED BY IDEAL WAREHOUSE INNOVATIONS, INC. LAMINATED PADS SHALL BE MADE FROM RECYCLED CONVEYOR BELTING AND TIRE RUBBER CUT TO 5.25" x 12" PUNCHED AND ASSEMBLED THROUGH 3/4" RODS BETWEEN 3" x 5" x 1/4" FORMED STEEL UNDER 1,500LBS OF PRESSURE. FINISH OF EXPOSED METAL SHALL BE PAINTED WITH WATER-BASED AND LEAD-FREE PAINT OR HOT-DIPPED GALVANIZED (OPTIONAL).

ALL DIMENSIONS ARE ± 1/8" UNLESS SPECIFIED OTHERWISE

DRAWN BY:

T.CHUNG

DATE:

2019-02-12

CHECKED BY:

DATE:

THE INFORMATION CONTAINED IN THIS DRAWING IS THE SOLE PROPERTY OF IDEAL WAREHOUSE INNOVATIONS INC. ANY REPRODUCTION IN PART OR AS A WHOLE IS PROHIBITED.



3rd Angle

SIZE:

A



IDEAL WAREHOUSE INNOVATIONS INC

DESCRIPTION:

STEEL-FACED LAMINATED BUMPER LB612-24SF

SCALE:

1:10

SHEETS:

1 of 1

DRAWING NUMBER:

MKT_LB612-24SF

REV:

1