

P1 CONFIG.

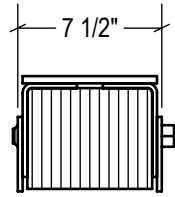

P2 CONFIG.

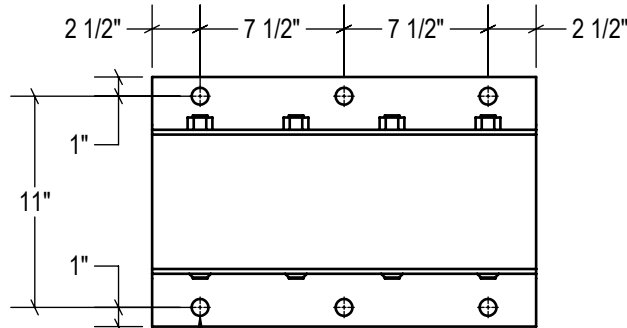

TOP VIEW

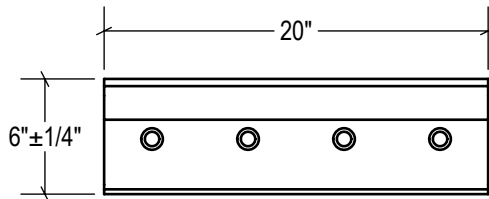

FRONT VIEW

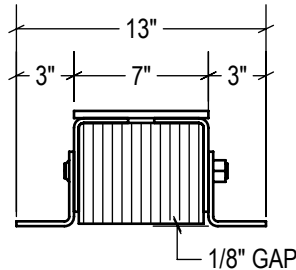

SIDE VIEW

STANDARD  
model #: LVB620-11SF  
part #: 22-2100  
Bolted (2) Sides

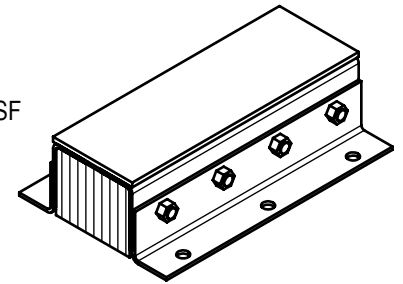

P1 CONFIG.  
model #: LVB620-11SF/P1  
part #: 22-2101  
Welded (1) Side

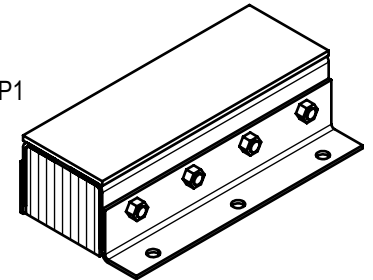

P2 CONFIG.  
model #: LVB620-11SF/P2  
part #: 22-2102  
Welded (2) Sides

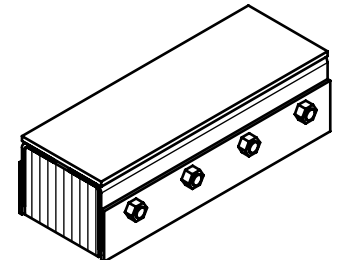

ESTIMATED GROSS SHIPPING WEIGHT = 85 LBS

**SPECIFICATIONS:**

FURNISH AND INSTALL STEEL-FACED LAMINATED RUBBER DOCK BUMPERS AS MANUFACTURED BY IDEAL WAREHOUSE INNOVATIONS, INC. LAMINATED PADS SHALL BE MADE FROM RECYCLED CONVEYOR BELTING AND TIRE RUBBER CUT TO 3.25" x 10" PUNCHED AND ASSEMBLED THROUGH 3/4" RODS BETWEEN 3" x 5" x 1/4" FORMED STEEL UNDER 1,500LBS OF PRESSURE. FINISH OF EXPOSED METAL SHALL BE PAINTED WITH WATER-BASED AND LEAD-FREE PAINT OR HOT-DIPPED GALVANIZED (OPTIONAL).

ALL DIMENSIONS ARE ± 1/8" UNLESS SPECIFIED OTHERWISE

DRAWN BY:

**T.CHUNG**

DATE:

**12/12/2018**

CHECKED BY:

DATE:

THE INFORMATION CONTAINED IN THIS DRAWING IS THE SOLE PROPERTY OF IDEAL WAREHOUSE INNOVATIONS INC. ANY REPRODUCTION IN PART OR AS A WHOLE IS PROHIBITED.



3rd Angle

SIZE:

**A**



**IDEAL WAREHOUSE INNOVATIONS INC**

DESCRIPTION:  
**STEEL-FACED LAMINATED BUMPER LVB620-11SF**

SCALE:  
**1:10**

SHEETS:  
**1 of 1**

DRAWING NUMBER:  
**MKT\_LVB620-11SF**

REV:  
**1**