

SECTION A-A

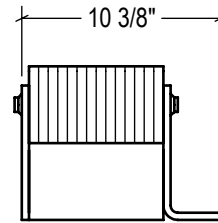

P1 CONFIG.

STANDARD  
model #: LVB824-11  
part #: -  
Bolted (2) Sides

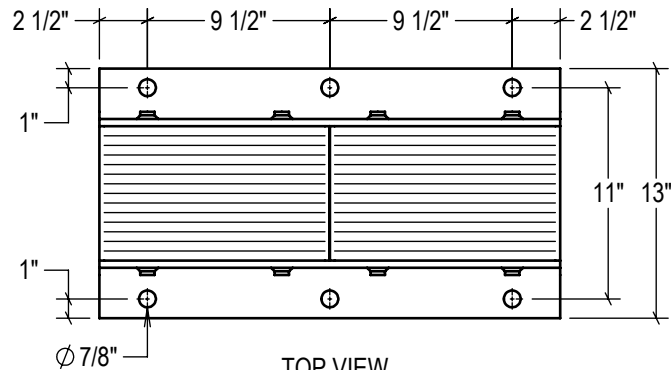
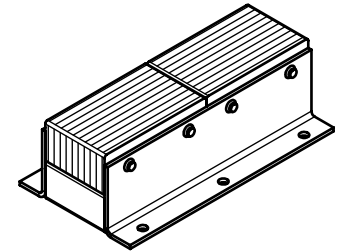

TOP VIEW

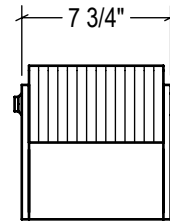

P2 CONFIG.

P1 CONFIG.  
model #: LVB824-11/P1  
part #: -  
Welded (1) Side

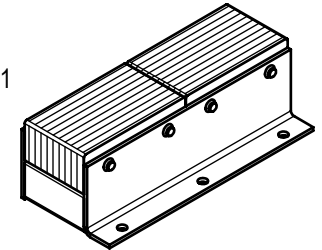

P2 CONFIG.  
model #: LVB824-11/P2  
part #: -  
Welded (2) Sides

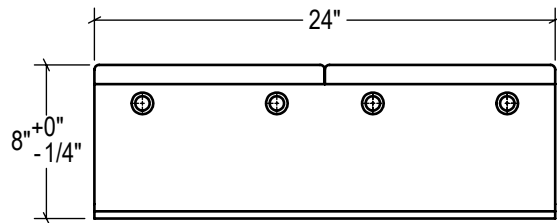
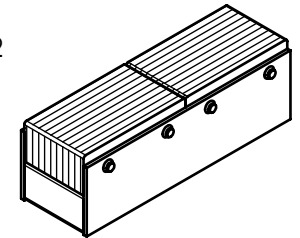

FRONT VIEW

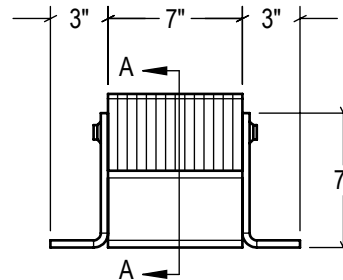

SIDE VIEW

ESTIMATED GROSS SHIPPING WEIGHT = 95 LBS

**SPECIFICATIONS:**

FURNISH AND INSTALL LAMINATED RUBBER DOCK BUMPERS AS MANUFACTURED BY IDEAL WAREHOUSE INNOVATIONS, INC. LAMINATED PADS SHALL BE MADE FROM REINFORCED TRUCK TIRES CUT TO 4.125" x 12" PUNCHED AND ASSEMBLED THROUGH 3/4" RODS BETWEEN FORMED 3/8" THICK STEEL UNDER 1,500LBS OF PRESSURE. FINISH OF EXPOSED METAL SHALL BE PAINTED WITH WATER-BASED AND LEAD-FREE PAINT OR HOT-DIPPED GALVANIZED (OPTIONAL).

ALL DIMENSIONS ARE ± 1/8" UNLESS SPECIFIED OTHERWISE

DRAWN BY:

**T.CHUNG**

DATE:

**2018-12-12**

CHECKED BY:

DATE:

THE INFORMATION CONTAINED IN THIS DRAWING IS THE SOLE PROPERTY OF IDEAL WAREHOUSE INNOVATIONS INC. ANY REPRODUCTION IN PART OR AS A WHOLE IS PROHIBITED.



3rd Angle

SIZE:

**A**



**IDEAL WAREHOUSE INNOVATIONS INC**

DESCRIPTION:  
**LAMINATED RUBBER BUMPER LVB824-11**

SCALE: <b>1:10</b>	SHEETS: <b>1 of 1</b>	DRAWING NUMBER: <b>MKT_LVB824-11</b>	REV: <b>1</b>
-----------------------	--------------------------	---	------------------