

P1 CONFIG.

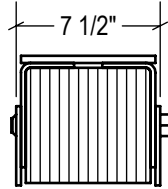

P2 CONFIG.

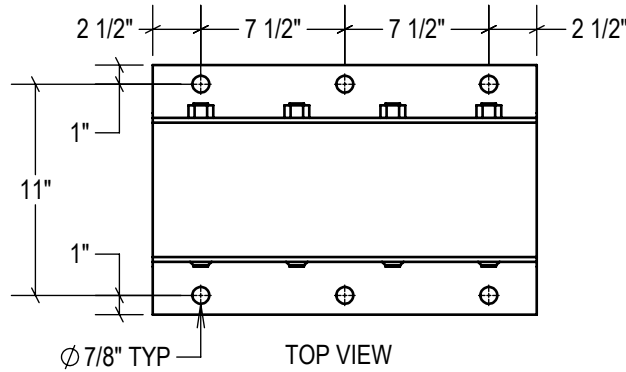

TOP VIEW

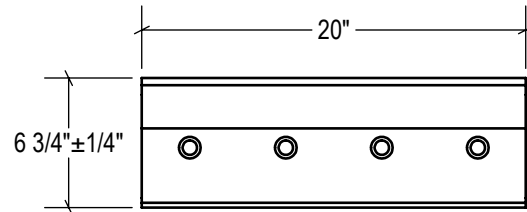

FRONT VIEW

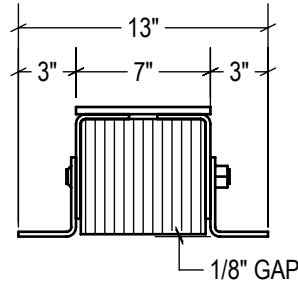

SIDE VIEW

STANDARD  
model #: TVB620-11SF  
part #: 22-6140  
Bolted (2) Sides

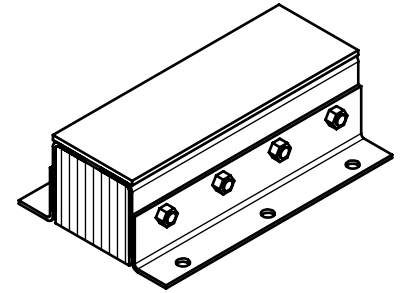

P1 CONFIG.  
model #: TVB620-11SF/P1  
part #: 22-6141  
Welded (1) Side

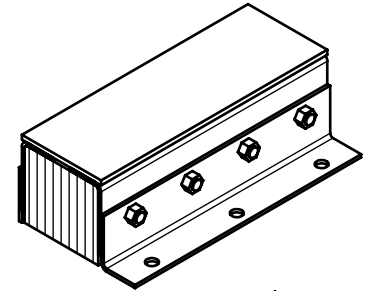

P2 CONFIG.  
model #: TVB620-11SF/P2  
part #: 22-6142  
Welded (2) Sides

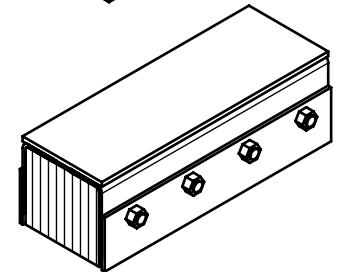

ESTIMATED GROSS SHIPPING WEIGHT = 91 LBS

**SPECIFICATIONS:**

FURNISH AND INSTALL STEEL-FACED LAMINATED RUBBER DOCK BUMPERS AS MANUFACTURED BY IDEAL WAREHOUSE INNOVATIONS, INC. LAMINATED PADS SHALL BE MADE FROM RECYCLED CONVEYOR BELTING AND TIRE RUBBER CUT TO 6.125" x 10" PUNCHED AND ASSEMBLED THROUGH 3/4" RODS BETWEEN 3" x 5" x 1/4" FORMED STEEL UNDER 1,500LBS OF PRESSURE. FINISH OF EXPOSED METAL SHALL BE PAINTED WITH WATER-BASED AND LEAD-FREE PAINT OR HOT-DIPPED GALVANIZED (OPTIONAL).

ALL DIMENSIONS ARE ± 1/8" UNLESS SPECIFIED OTHERWISE

DRAWN BY:

**T.CHUNG**

DATE:

**2018-12-12**

CHECKED BY:

DATE:

THE INFORMATION CONTAINED IN THIS DRAWING IS THE SOLE PROPERTY OF IDEAL WAREHOUSE INNOVATIONS INC. ANY REPRODUCTION IN PART OR AS A WHOLE IS PROHIBITED.



3rd Angle

SIZE:

**A**



**IDEAL WAREHOUSE INNOVATIONS INC**

DESCRIPTION:  
**STEEL-FACED LAMINATED BUMPER TVB620-11SF**

SCALE: <b>1:10</b>	SHEETS: <b>1 of 1</b>	DRAWING NUMBER: <b>MKT_TV620-11SF</b>	REV: <b>1</b>
-----------------------	--------------------------	--	------------------