

P1 CONFIG.

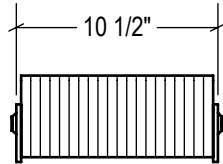

P2 CONFIG.

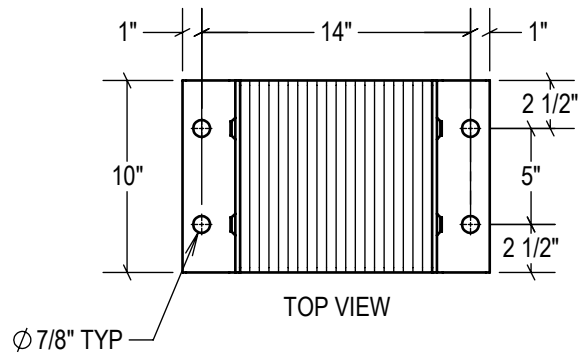

TOP VIEW

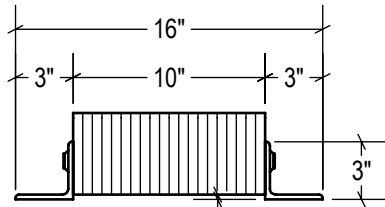

FRONT VIEW

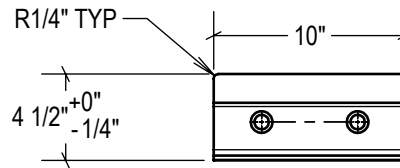

SIDE VIEW

STANDARD
model #: ECONO-LB410-14
part #: 27-1040
Bolted (2) Sides

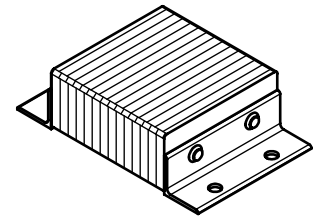

P1 CONFIG.
model #: ECONO-LB410-14/P1
part #: 27-1041
Welded (1) Side

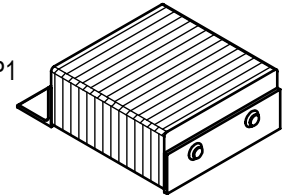

P2 CONFIG.
model #: ECONO-LB410-14/P2
part #: 27-1042
Welded (2) Sides

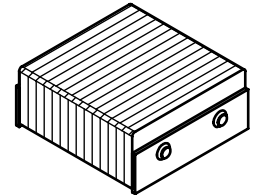

ESTIMATED GROSS SHIPPING WEIGHT = 31 LBS

SPECIFICATIONS:

FURNISH AND INSTALL LAMINATED RUBBER DOCK BUMPER AS MANUFACTURED BY IDEAL WAREHOUSE INNOVATIONS, INC. LAMINATED PADS SHALL BE MADE FROM USED CONVEYOR BELTING CUT TO 4.125" x 10" PUNCHED AND ASSEMBLED THROUGH 3/4" RODS BETWEEN 3" x 3" x 1/4" STRUCTURAL STEEL UNDER 1,500LBS OF PRESSURE. FINISH OF EXPOSED METAL SHALL BE PAINTED WITH WATER-BASED AND LEAD-FREE PAINT OR HOT-DIPPED GALVANIZED (OPTIONAL).

ALL DIMENSIONS ARE ± 1/4" UNLESS SPECIFIED OTHERWISE

DRAWN BY:
T.CHUNG

DATE:
2018-12-12

CHECKED BY:

DATE:

THE INFORMATION CONTAINED IN THIS DRAWING IS THE SOLE PROPERTY OF IDEAL WAREHOUSE INNOVATIONS INC. ANY REPRODUCTION IN PART OR AS A WHOLE IS PROHIBITED.



SIZE:
A



IDEAL WAREHOUSE INNOVATIONS INC

DESCRIPTION:
ECONO LAMINATED RUBBER BUMPER LB410-14

SCALE:
1:10

SHEETS:
1 of 1

DRAWING NUMBER:
MKT_LB410-14E

REV:
2