

P1 CONFIG.

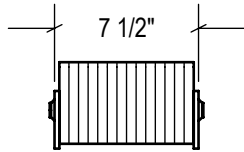

P2 CONFIG.

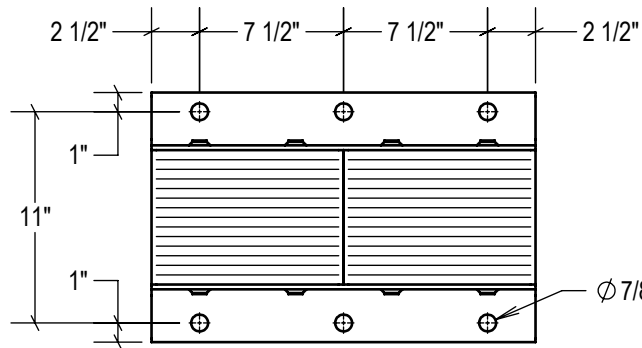

TOP VIEW

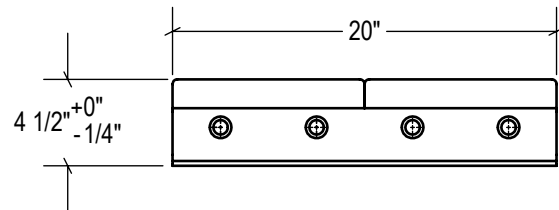

FRONT VIEW

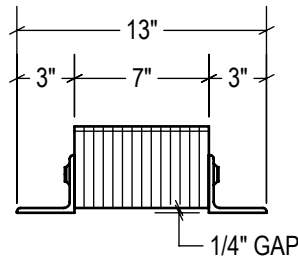

SIDE VIEW

STANDARD  
model #: ECONO-LVB420-11  
part #: 27-1100  
Bolted (2) Sides

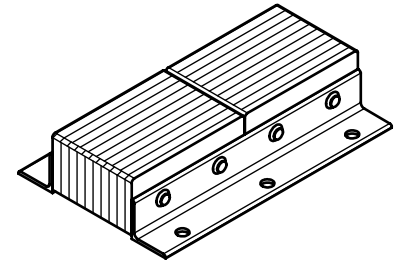

P1 CONFIG.  
model #: ECONO-LVB420-11/P1  
part #: 27-1101  
Welded (1) Side

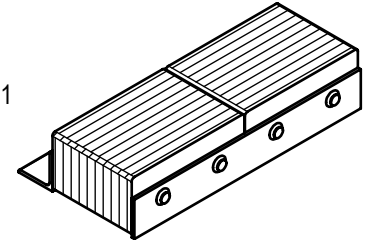

P2 CONFIG.  
model #: ECONO-LVB420-11/P2  
part #: 27-1102  
Welded (2) Sides

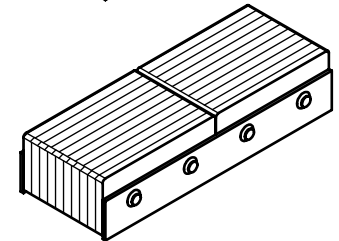

ESTIMATED GROSS SHIPPING WEIGHT = 48 LBS

**SPECIFICATIONS:**

FURNISH AND INSTALL LAMINATED RUBBER DOCK BUMPERS AS MANUFACTURED BY IDEAL WAREHOUSE INNOVATIONS, INC. LAMINATED PADS SHALL BE MADE FROM USED CONVEYOR BELTING CUT TO 4.125" x 10" PUNCHED AND ASSEMBLED THROUGH 3/4" RODS BETWEEN 3" x 3" x 1/4" STRUCTURAL STEEL UNDER 1,500LBS OF PRESSURE. FINISH OF EXPOSED METAL SHALL BE PAINTED WITH WATER-BASED AND LEAD-FREE PAINT OR HOT-DIPPED GALVANIZED (OPTIONAL).

ALL DIMENSIONS ARE  $\pm 1/4''$  UNLESS SPECIFIED OTHERWISE

DRAWN BY:

**T.CHUNG**

DATE:

**2018-12-12**

CHECKED BY:

DATE:

THE INFORMATION CONTAINED IN THIS DRAWING IS THE SOLE PROPERTY OF IDEAL WAREHOUSE INNOVATIONS INC. ANY REPRODUCTION IN PART OR AS A WHOLE IS PROHIBITED.



3rd Angle

SIZE:

**A**



**IDEAL WAREHOUSE INNOVATIONS INC**

DESCRIPTION:

**ECONO LAMINATED RUBBER BUMPER LVB420-11**

SCALE:

**1:10**

SHEETS:

**1 of 1**

DRAWING NUMBER:

**MKT\_LVB420-11E**

REV:

**2**