

P1 CONFIG.

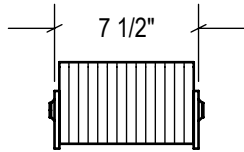

P2 CONFIG.

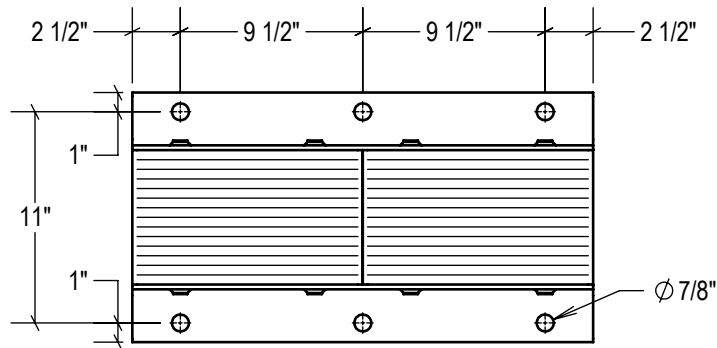

TOP VIEW

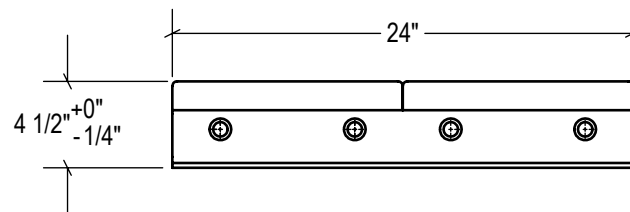

FRONT VIEW

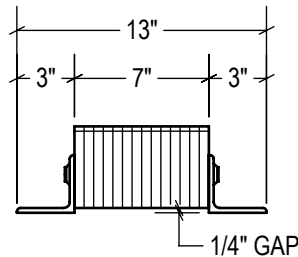

SIDE VIEW

STANDARD
model #: ECONO-LVB424-11
part #: 27-1103
Bolted (2) Sides

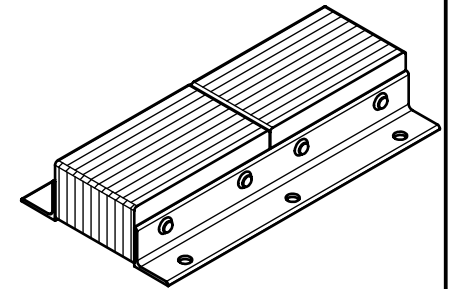

P1 CONFIG.
model #: ECONO-LVB424-11/P1
part #: 27-1104
Welded (1) Side

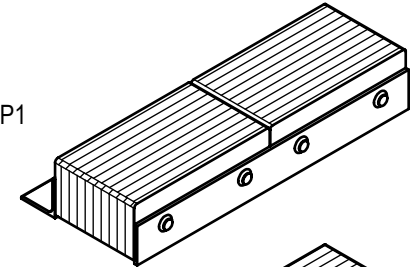

P2 CONFIG.
model #: ECONO-LVB424-11/P2
part #: 27-1105
Welded (2) Sides

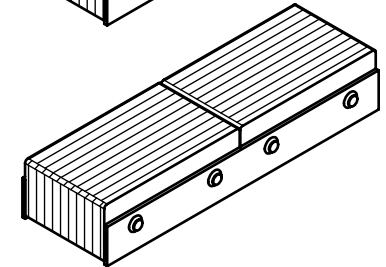

ESTIMATED GROSS SHIPPING WEIGHT = 57 LBS

SPECIFICATIONS:

FURNISH AND INSTALL LAMINATED RUBBER DOCK BUMPERS AS MANUFACTURED BY IDEAL WAREHOUSE INNOVATIONS, INC. LAMINATED PADS SHALL BE MADE FROM USED CONVEYOR BELTING CUT TO 4.125" x 12" PUNCHED AND ASSEMBLED THROUGH 3/4" RODS BETWEEN 3" x 3" x 1/4" STRUCTURAL STEEL UNDER 1,500LBS OF PRESSURE. FINISH OF EXPOSED METAL SHALL BE PAINTED WITH WATER-BASED AND LEAD-FREE PAINT OR HOT-DIPPED GALVANIZED (OPTIONAL).

ALL DIMENSIONS ARE $\pm 1/4''$ UNLESS SPECIFIED OTHERWISE

DRAWN BY:

T.CHUNG

DATE:

2018-12-12

CHECKED BY:

DATE:

THE INFORMATION CONTAINED IN THIS DRAWING IS THE SOLE PROPERTY OF IDEAL WAREHOUSE INNOVATIONS INC. ANY REPRODUCTION IN PART OR AS A WHOLE IS PROHIBITED.



3rd Angle

SIZE:

A



IDEAL WAREHOUSE INNOVATIONS INC

DESCRIPTION:

ECONO LAMINATED RUBBER BUMPER LVB424-11

SCALE:

1:10

SHEETS:

1 of 1

DRAWING NUMBER:

MKT_LVB424-11E

REV:

2