

INSTALLATION NOTES

INSPECT THE SITE AND ENSURE ALL PARTS ARE PRESENT

CLEAN THE AREA OF ANY DEBRIS BEFORE INSTALLING GUARDRAILS AND ACCESSORIES

SAFETY PRECAUTIONS

USE APPROPRIATE PERSONAL PROTECTIVE EQUIPMENT SUCH AS GLOVES, SAFETY GLASSES, HEARING PROTECTION AND PROTECTIVE SHOES.

ANCHOR BOLTS

THE SUPPLIED ANCHOR BOLTS REQUIRE AN MINIMUM EMBEDDED DEPTH OF 2-1/4"

TIGHTEN THE NUT TO THE INSTALLATION TORQUE OF 40 ft/lbf [55 N-m]

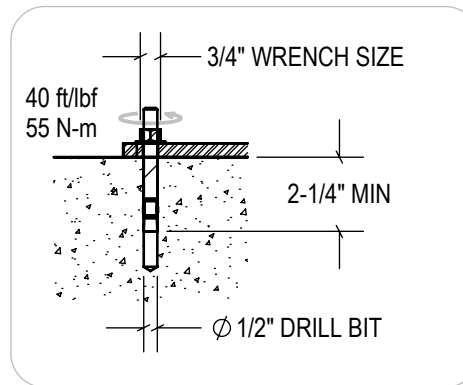

BOLT TIGHTENING

INITIALLY TIGHTEN THE JOINT TO A SNUG TIGHT CONDITION. SNUG TIGHT IS WHEN THE BOLTED CONNECTION HAS BEEN TIGHTENED TO A POINT WHERE ALL THE COMPONENTS ARE IN FIRM CONTACT.

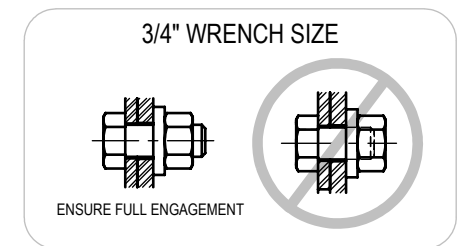

ENSURE THAT THE NUT IS FULLY ENGAGED WITH THE BOLT AND THAT A FEW THREADS PROJECT FROM THE REAR OF THE BOLT AFTER THE JOINT IS IN A SNUG TIGHT CONDITION. OTHERWISE, A LONGER BOLT WILL BE NEEDED TO ENSURE FULL STRENGTH.

DO NOT OVERTIGHTEN BOLTS. ONLY TIGHTEN THE JOINT BY 1/3 OF A TURN PAST THE SNUG TIGHT CONDITION



TOOLS REQUIRED FOR INSTALLATION

- MEASURING TAPE
- CHALK LINE
- 2FT LEVEL
- HAMMER DRILL WITH A 1/2" DRILL BIT
- 3/4" SOCKET WRENCH AND/OR ADJUSTABLE WRENCH

 3rd Angle	SIZE: A	 IDEAL WAREHOUSE INNOVATIONS INC
DESCRIPTION: GUARDRAIL SYSTEMS INSTALLATION		
SCALE: 1:16	SHEETS: 1 of 1	DRAWING NUMBER: INS-01.01-R1

INSTALLATION INSTRUCTIONS

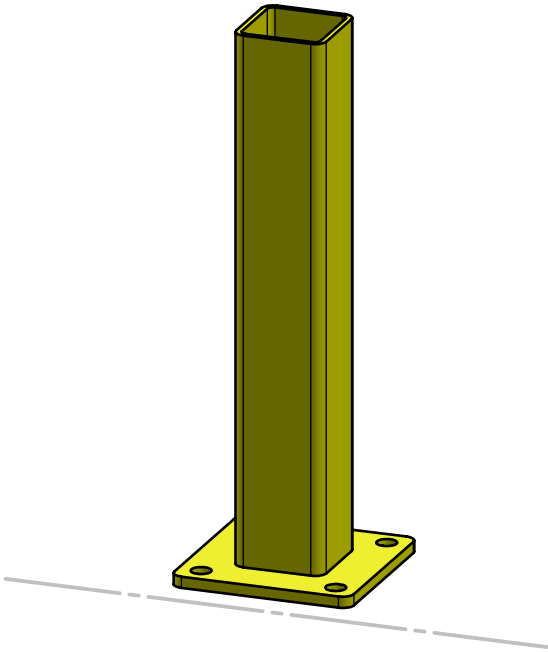

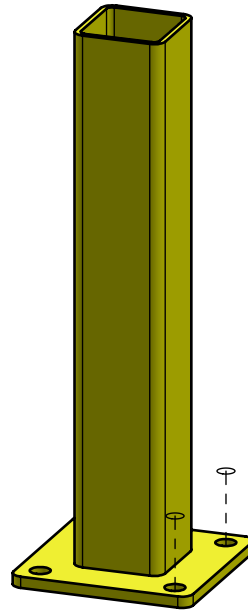

STEP 1:
POSITION THE BOLLARD
IN THE DESIRED LOCATION

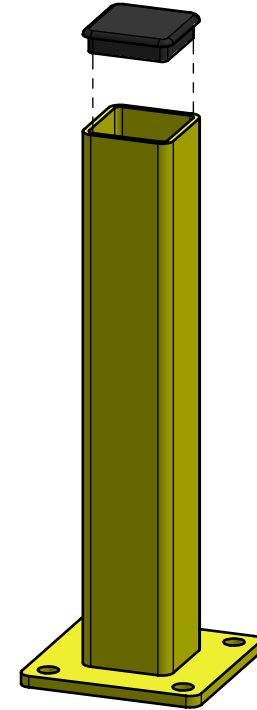

STEP 2:
LAG THE BOLLARD TO THE FLOOR
USING PROVIDED ANCHORS
AND SPECIFICATIONS



STEP 3:
ADD BOLLARD CAP

 3rd Angle	SIZE: A	 IDEAL WAREHOUSE INNOVATIONS INC
DESCRIPTION: BOLLARD INSTALLATION		
SCALE: 1:8	SHEETS: 1 of 1	DRAWING NUMBER: INS-10.01-R2